

Guide to the KITTYLAND

Thank you for choosing the KITTYLAND.

We are confident this product will be as attractive and satisfying to you and your kitty. KITTYLAND design for quick and easy assembly, no tools needed to assemble any of the KITTYLAND. Follow the simple steps in this guide, and your kitty will waste no time to moving into his new land.

Kittyland Hideaway Play Tower

Item No.: 53116L









**Assembled Size: 115x80x105cm
(46x32x42inch)**

Product Composition
ABS, Cardboard, Polyester, PVC
Maximum Kitty Weight : 8kg
Made in China





THIS UNIT CONTAINS:

Actual product may vary from photo

No.	Qty.	Description	No.	Qty.	Description
A1	1 x	 Sisal Post	B28	8 x	 28cm Curved Tube
A2	1 x	 Toy Sisal Post	B40	4 x	 40cm Curved Tube
A35	37x	 35cm Tube	2C	2 x	 2-way Connector
			3S	4 x	 3-way Connector
			3C	6 x	 3-way Corner Connector

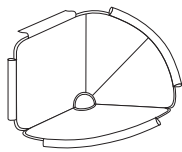
THIS UNIT CONTAINS:

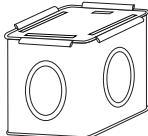
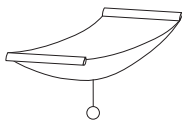
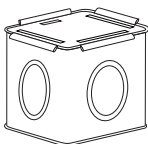
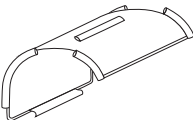
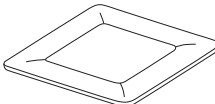
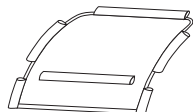
No.	Qty.	Description	No.	Qty.	Description
4C	8 x	 4-way Connector	E2	1 x	 Jute Play Corner (Rightward)
5C	6 x	 5-way Connector			
6C	1 x	 6-way Connector			
D1	1 x	 Hideaway Cube (Rightward)	H	1 x	 Plush Hammock with Toy
D2	1 x	 Hideaway Cube (Leftward)	R1	1 x	 Jute Roof
M1	2 x	 Square Plush Mat	S1	1 x	 Jute Climbing Ramp

Step 1: Assemble the bottom frame of Part 1

Step 2: Assemble Jute Ramp

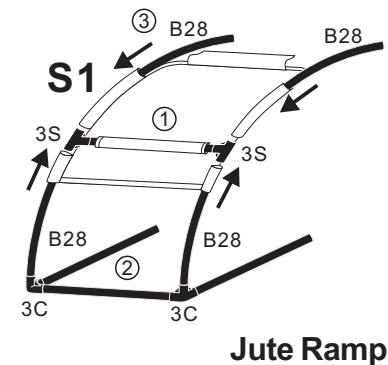
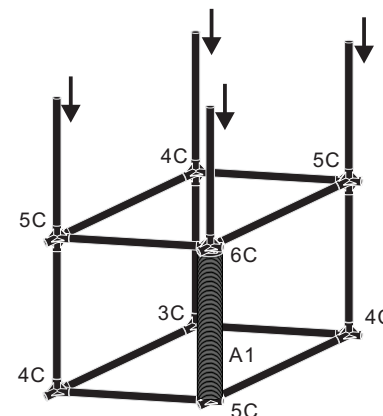

ASSEMBLY INSTRUCTION:

Step 3: Assemble the Part 1

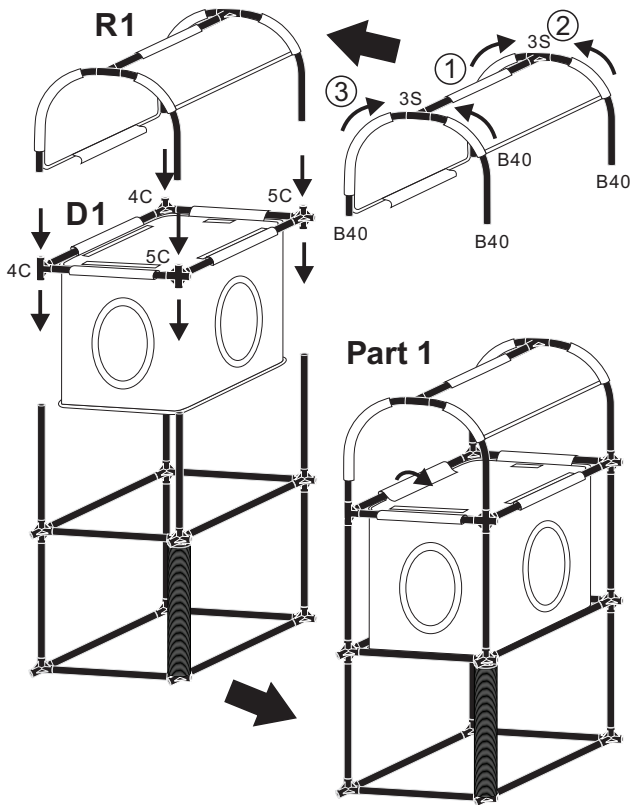

Step 4: Assembly the Jute Play Corner

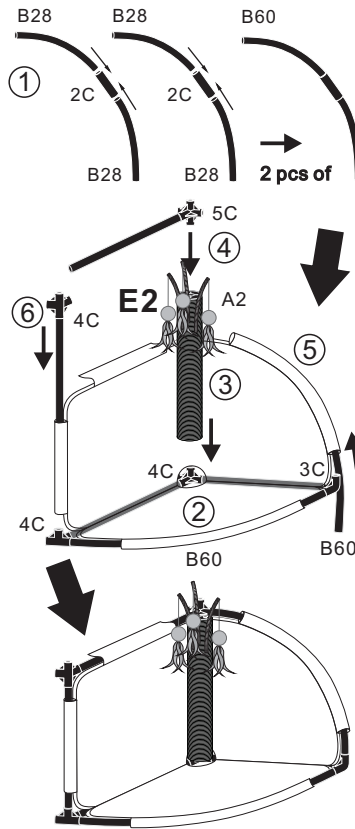

Step 6: Connect all the parts together

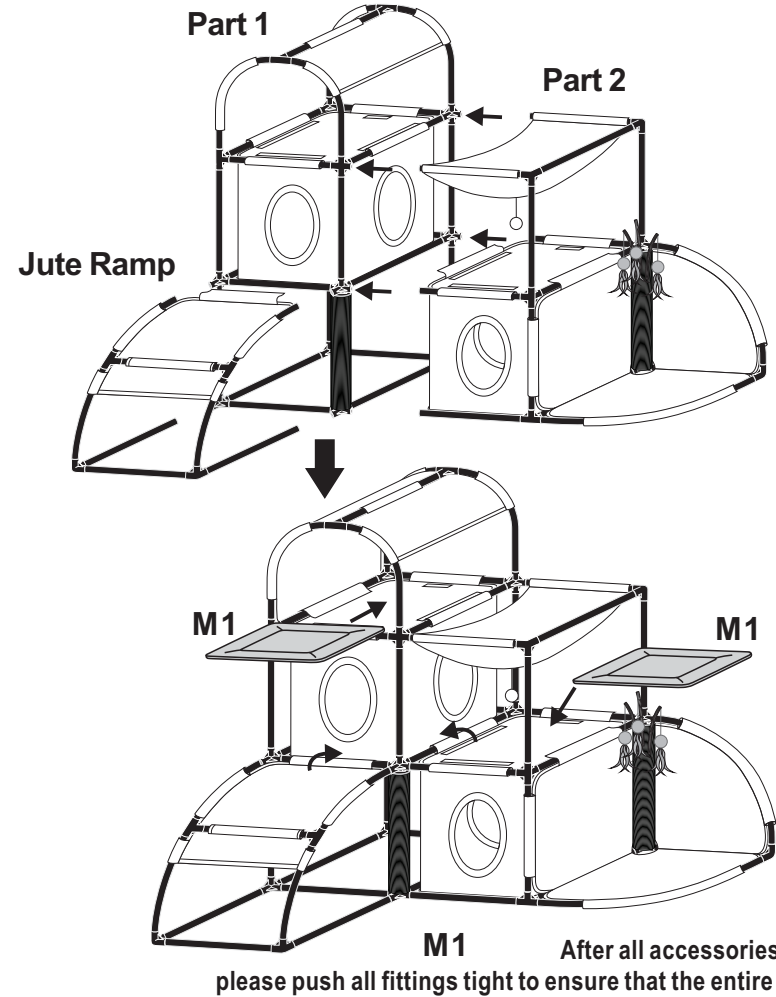

Step 5: Assemble the Part 2

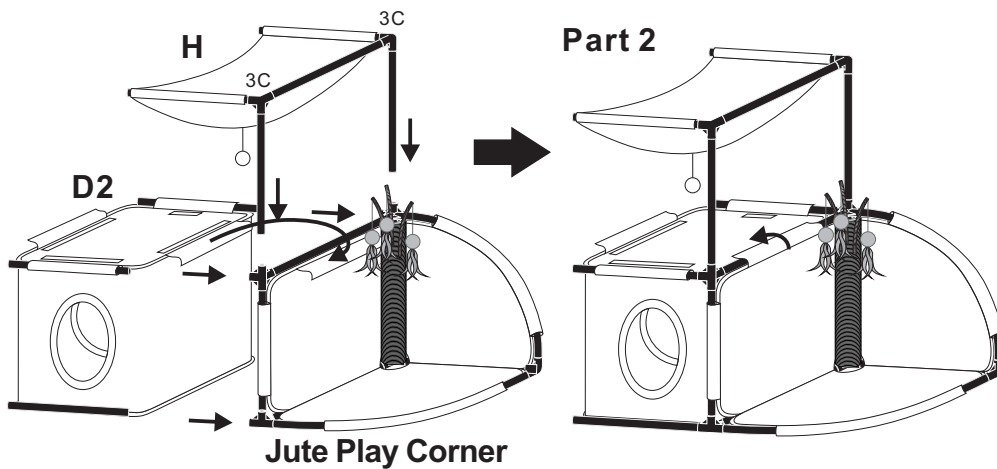

Notice:

- (1) This product is used only for small cats rest and play, not suitable for other purposes, when using, do not exceed the maximum load to bear.
- (2) After the initial installation, please check if the connectors are in place and ensure all components connected firmly. Check the product regularly.
- (3) The main frame of this product is plastic. Install the product with appropriate force in order to avoid unnecessary damage. In case of any damage in the course of the product usage, Stop using immediately, remove the damaged parts and replaced with related new components.
- (4) This product is recommendedly placed by the wall. Do not close to open flame, high temperature equipment or used near damaged items.

Care Instructions:

Spot clean, moist towel, air dry thoroughly. Do not immerse in water.